

AGITBG 520

52cm Undermount Rangehood



TECHNICAL SPECIFICATIONS	
Construction Type/Product Family	Undermount rangehood
Speed settings	4
Lighting type / Position	LED light strip / Front
Control Type	Buttons
Colour	Black glass
Airflow	800m ³ /h
Filter Type	Aluminium
Motor	Single
dB Rating	45dB (min) to 70dB (max)
Ducting diameter	150mm
Location & Length of Power Cable	
Electrical Connect Requirements	
Voltage (V)	
Frequency (Hz)	
Approval Certificates	CE

FEATURES & BENEFITS



800m³/h Extraction

Removes cooking odours with ease



Noise Rating from 45dB

Quiet operation makes this unit perfect for open plan kitchens.



LED Lighting

Giving extra light when needed in the kitchen.



4 Speed Settings

Depending on what you're cooking you can vary the amount of extraction as required.



5 YEAR WARRANTY on parts and labour.

DIMENSIONS	
Product Dimensions (W) x (H) x (D)	520 x 290 x 308
Built-In Hole Dimensions (W) x (D)	502 x 265
Weight	

AGITBG 520

52cm Undermount Rangehood



Product dimensions

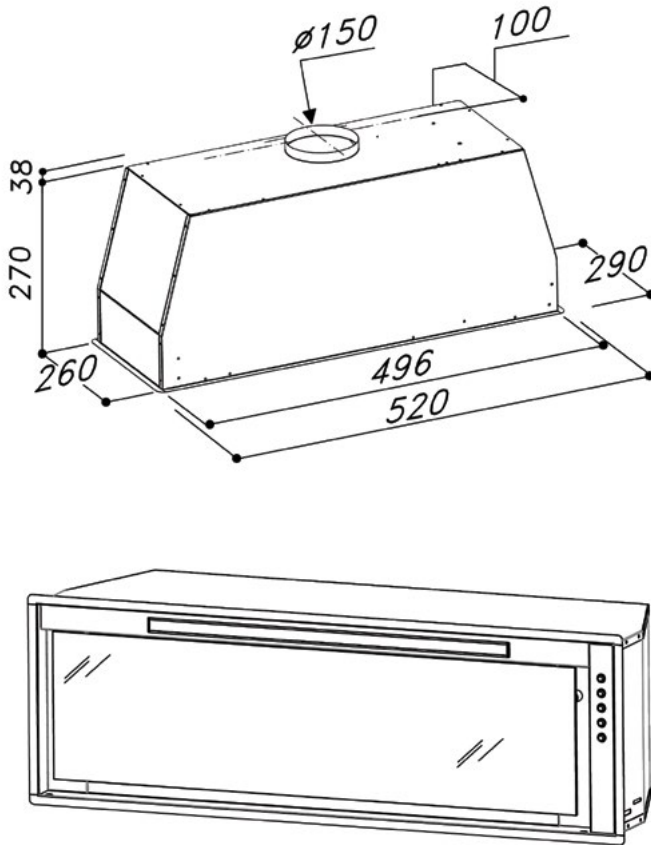

Rangehood/cooktop clearance

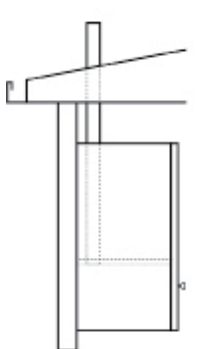
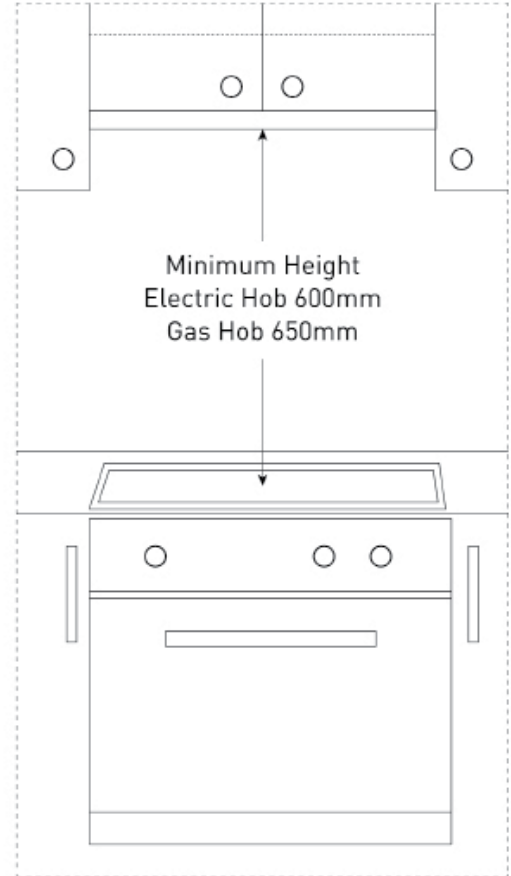

TOP DUCTING

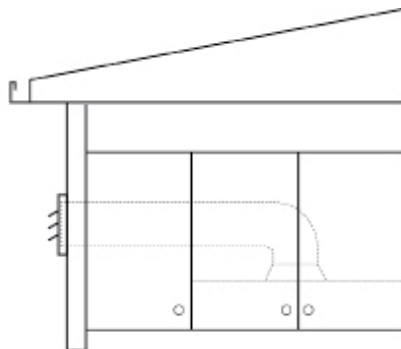

SIDE DUCTING

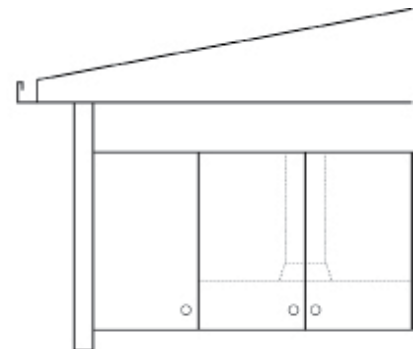

RE-CIRCULATING
(Carbon filter required)

WARNING: Technical specifications and product sizes can be varied by the manufacturer, without notice. Cut outs for appliances should only be by physical product measurements. The above is indicative only.