

# ARU75BX-L

75cm Undermount Rangehood



## FEATURES & BENEFITS



### 1000m<sup>3</sup>/h Extraction

Removes cooking odours with ease



### 50/62/64 dB Noise Rating

Quiet operation makes this unit perfect for open plan kitchens.



### LED Lighting

Giving extra light when needed in the kitchen.



### 3 Speed Settings

Depending on what you're cooking you can vary the amount of extraction as required.



**5 YEAR WARRANTY** on parts and labour.

## TECHNICAL SPECIFICATIONS

Construction Type/Product Family	Undermount rangehood
Speed settings	3
Lighting type / Position	LED / Front
Control Type	Sliding switch
Colour	Stainless steel
Filter Type	Aluminium or Optional Carbon Filter
Motor	Single
dB Rating	50/62/64
Ducting diameter	150mm
Location & Length of Power Cable	
Electrical Connect Requirements	
Voltage (V)	
Frequency (Hz)	
Approval Certificates	CE

## DIMENSIONS

Product Dimensions (W) x (H) x (D)	750 x 254 x 296
Package Dimensions (W) x (H) x (D)	
Built-In Hole Dimensions (W) x (D)	710 x 262
Weight	9kg

# ARU75BX-L

75cm Undermount Rangehood



## Product dimensions

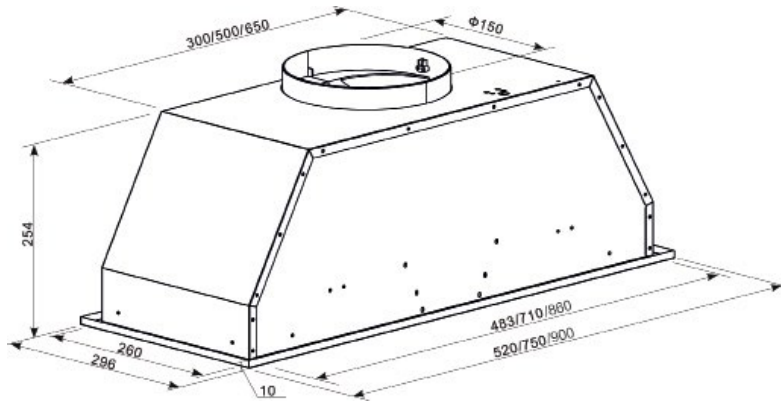

## Rangehood/cooktop clearance

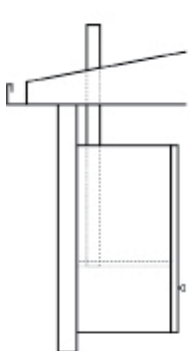
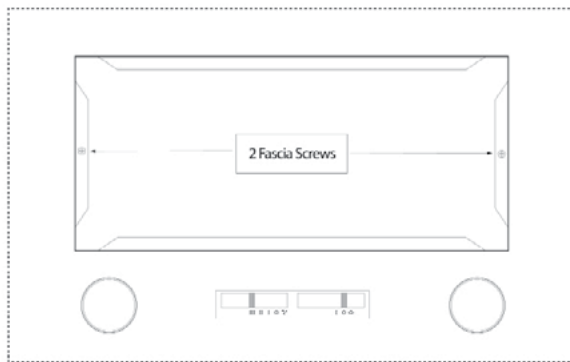
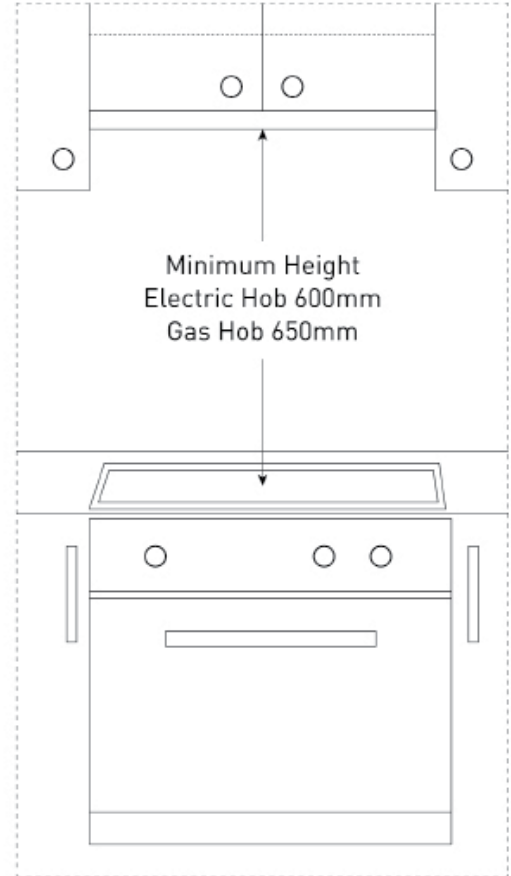

TOP DUCTING

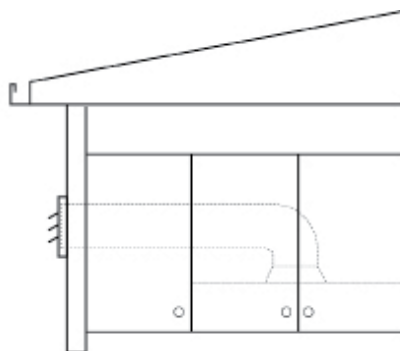

SIDE DUCTING

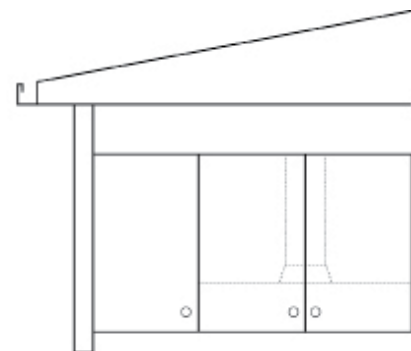

RE-CIRCULATING  
(Carbon filter required)

**WARNING:** Technical specifications and product sizes can be varied by the manufacturer, without notice. Cut outs for appliances should only be by physical product measurements. The above is indicative only.