



Before using your washing machine, please read this manual carefully and keep it for future reference.

Twin Tub Washing Machine

OWNER'S MANUAL

MODEL:MTC80-P1101PQ/AU09

Read This Manual

Inside you will find many helpful hints on how to use and maintain your washing machine properly. Just a little preventative care on your part can save you a great deal of time and money over the life of your washing machine. You'll find many answers to common problems in the chart of troubleshooting tips. If you review the chart of troubleshooting tips first, you may not need to call for service.



TABLE OF CONTENTS







































Safety Precaution	1
Attention To Installation	2
Lay upper drain hose	2
Change the position of the drain hose	2
Installation site	2
Preparation Instructions	3
Reference of laundry quantity corresponding to different capacities	3
Laundry volume and detergent dosage reference	3
Name Of Parts	4
Accessories	4
Introduction Of Control Panel	4
Quick Start	5
Washing Method	5
Rinsing Method	5
Spinning Method	6
Efficiency Program	7
Special Features	7
Soak function	7
Buzzer function	7
The dual voltage	7
Attention To Maintenance	8
Cabinet maintenance	8
Cleaning the lint filter	8
Anti-freezing protection	8
Operation when objects are dropped into outside of the spin tub	8
Notes	8
Main Technical Parameters	9

SAFETY PRECAUTION

Safety Precaution

Be sure to comply with the following to prevent damage to body and property of you and others:

	The sign stands for "pay attention", and the picture of specific items needs attention shows in Δ .
	The sign stands for "forbid", and the picture of specific items forbidden shows in O .
	The sign stands for "must do", and the picture of specific items must be done shows in \bullet .

<p>Do not dismantle the machine by yourself.</p>   <p>Forbid dismantling</p>	<p>Do not install the machine in damp or rainy environment to avoid electric shock, fire, machine failure, or deformation.</p>   <p>Avoid dampness</p>	<p>Do not place inflammable materials like burning candle, mosquito incense, cigaret etc. or heating source like electric stove, calorifier etc. on the machine.</p>   <p>Forbid</p>	<p>Do not spray water directly to the machine.</p>   <p>Avoid spraying water</p>
<p>Do not let baby sit on it or place heavy things on it.</p>   <p>Forbid</p>	<p>Do not wash clothes that are stained with kerosene, petrol, alcohol, and other flammable substance.</p>   <p>Forbid</p>	<p>Make sure that the water inlet hose is connected and the tap is opened before washing.</p>   <p>Forbid</p>	<p>Do not exceed the max. water level to avoid water overflowing and machine failure.</p>   <p>Forbid</p>
<p>To avoid electric shock resulting from electric leakage, please connect grounding wire of the plug properly.</p>   <p>Grounding</p>	<p>Do not let baby climb to the machine or play near running tub to avoid accident.</p>   <p>Forbid</p>	<p>If use warm water, the water temperature should not exceed 50°C.</p>   <p>Forbid</p>	<p>Do not wash down-filled coat, raincoat or similar clothes.</p>   <p>Forbid</p>
<p>Wipe off dirty and dust on the plug often to prevent poor contact with power supply.</p>   <p>Forbid</p>	<p>Do not put hands into the tub before it stopping running.</p>   <p>Forbid putting into</p>	<p>Do not replace power cord by yourself.</p>   <p>Forbid</p>	<p>Do not damage the power cord and plug to avoid electric shock, short circuit or fire.</p>   <p>Forbid</p>
<p>Insert the plug tightly when use.</p>   <p>Forbid</p>	<p>Do not pull the cord when unplug the plug.</p>   <p>Forbid</p>	<p>Do not insert or unplug the plug with wet hands to avoid electric shock.</p>   <p>Forbid wet hands</p>	<p>Unplug the plug from socket after use.</p>   <p>Unplug the plug</p>

Installation

Attention To Installation

Lay upper drain hose

- Needs a drain hose with minimum diameter of 3 cm, and minimum carry away capacity of 40 liters per minute.
- For upper drain system, the drain hose must be placed at least 86 cm(30 inches) from the bottom of washer, but not higher than 100 cm.

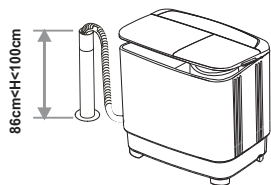

FOR UPPER DRAIN SYSTEM ONLY

Change the position of the drain hose

The ex-factory installation position of the drain hose is located at the spin side. According to the installation site, the drain hose can also be installed at the wash side of the machine. The method is as follows:

- ① Unplug the power cord and empty water in the drain hose completely.
- ② Spread a piece of soft cloth on the floor (e.g. a blanket) and place the washing machine on it gently.
- ③ Take the drain hose out from the buckle at the spin side, and put it into the buckle at the wash side.
- ④ Hang up the drain hose kit.

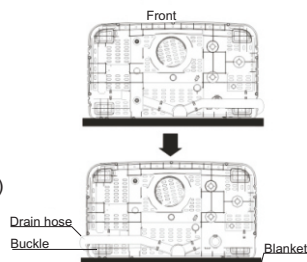

FOR LOWER DRAIN SYSTEM ONLY

Installation site

In order to avoid electrical failure, discoloration and deformation, do not install the machine in the following places:

- Locations exposed to direct sunlight
- Locations exposed to rain or snow
- Locations with uneven or unstable ground



Usage method

Preparation Instructions

- Plug in power and connect the water inlet hose.
- Lay down the lower drain hose and connect it to the sewer, or lay the upper drain hose to places as indicated in page 2.
- Check that there are no objects such as coins, hairpins, mud or sand in the pocket.
- Strings should be knotted in advance to prevent entanglement.
- Clothes can be classified for washing according to the texture, dirty degree and color.
- For small pieces (e.g., stockings) or fluffy clothes, put them into a nylon net for washing.

Attachment: Reference of laundry quantity corresponding to different capacities

Laundry Capacity	Shirt about 500 g	Uniform about 650 g	Jeans about 900 g	Jacket about 1600 g
2.0kg Capacity	about 4 pcs.	about 3 pcs.	about 2 pcs.	about 1 pcs.
3.0kg Capacity	about 6 pcs.	about 4 pcs.	about 3 pcs.	about 1 pcs.
3.6kg Capacity	about 7 pcs.	about 5 pcs.	about 4 pcs.	about 2 pcs.
4.6kg Capacity	about 9 pcs.	about 6 pcs.	about 5 pcs.	about 2 pcs.
5.0kg Capacity	about 10 pcs.	about 7 pcs.	about 5 pcs.	about 3 pcs.
5.5kg Capacity	about 11 pcs.	about 8 pcs.	about 6 pcs.	about 3 pcs.
6.0kg Capacity	about 12 pcs.	about 9 pcs.	about 6 pcs.	about 3 pcs.
7.0kg Capacity	about 14 pcs.	about 10 pcs.	about 7 pcs.	about 4 pcs.
7.5kg Capacity	about 15 pcs.	about 11 pcs.	about 8 pcs.	about 4 pcs.
8.0kg Capacity	about 16 pcs.	about 11 pcs.	about 8 pcs.	about 4 pcs.
8.5kg Capacity	about 17 pcs.	about 12 pcs.	about 9 pcs.	about 5 pcs.
10.0kg Capacity	about 20 pcs.	about 15 pcs.	about 10 pcs.	about 6 pcs.
12.0kg Capacity	about 24 pcs.	about 18 pcs.	about 13 pcs.	about 7 pcs.
.....

- The figure above is for reference only, specific weights are subject to actual clothes.

Attachment : Laundry volume and detergent dosage reference

Fabric type	Laundry capacity (kg)	Water level	Water flow	Wash time (minutes)	Detergent amount (g)
Synthetics, silk, Delicate fabrics	0-5.0	Low	Gentle	3	About 50
	5.0-6.5	Mid		3-5	About 61
Cotton or linen	0-6.5	Mid	Gentle	7	About 61
	6.5-8.0	High		7-10	About 77
Heavy soils	0-6.5	Mid	Normal	10	About 61
	6.6-8.0	High		10-35(soak 20)	About 77

- The dosage of washing detergent varies according to dirty degree and texture of laundries.

Structure Instruction

Name Of Parts

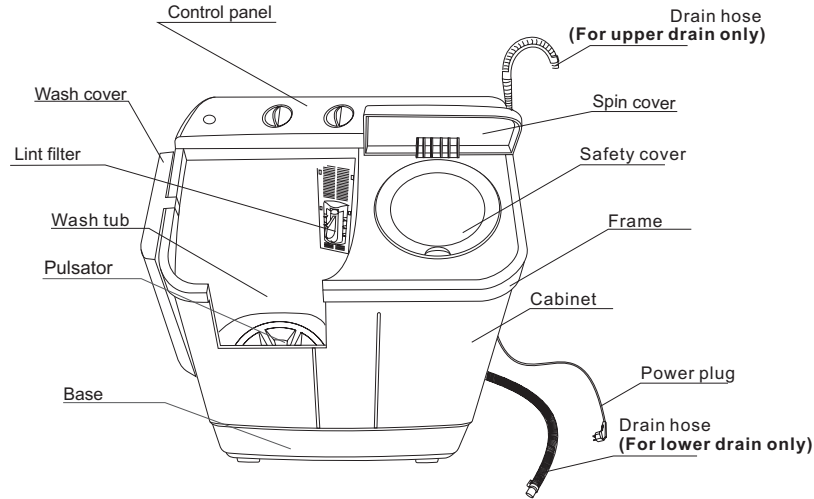

Accessories

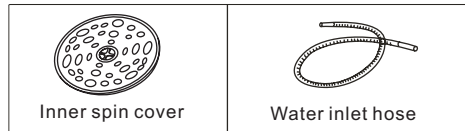

Introduction Of Control Panel

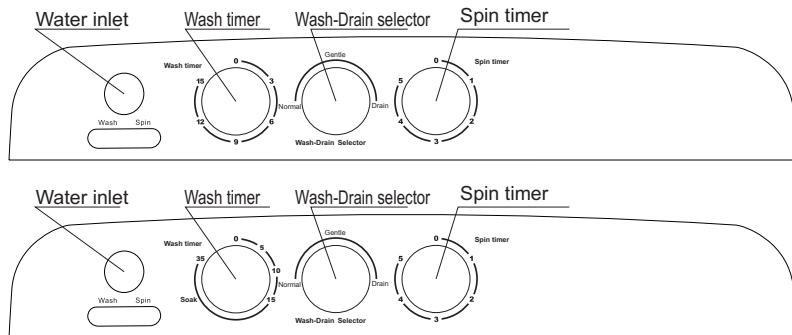

※The drawing above is for reference only, specific drawing is subject to actual models.

- Water inlet: be used to inject water.
- Wash timer: be used to select required washing time.
- Spin timer: be used to select required spinning time.
- Wash-Drain selector: For washing or rinsing, select "Gentle" or "Normal". For Draining, select "Drain".

Usage method

Quick Start

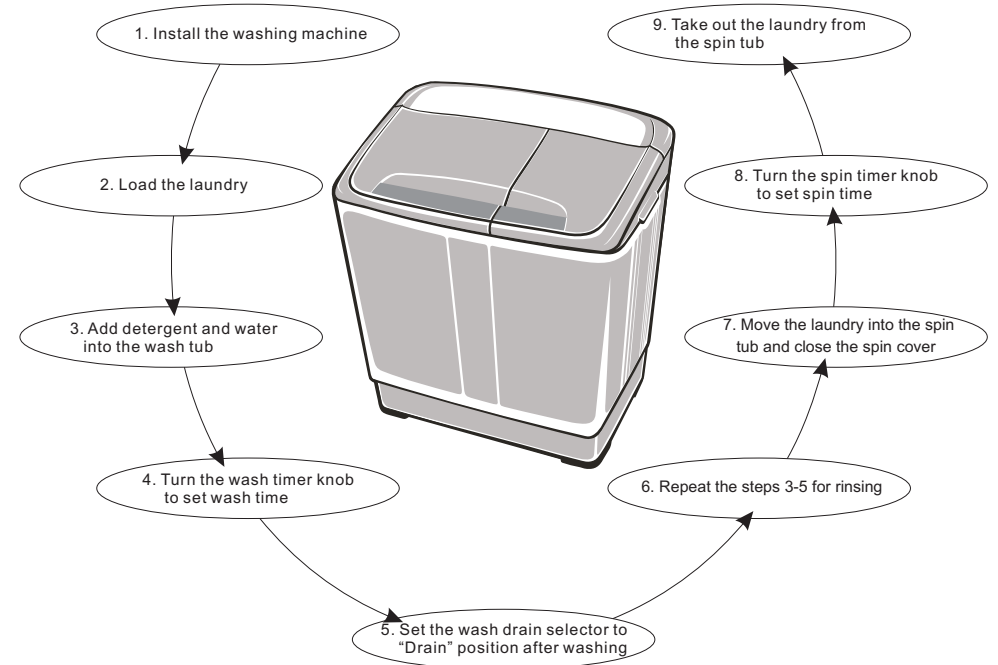

Washing Method

1. Insert the water inlet hose into the water inlet mouth, and choose injecting water to the wash tub.
2. Put the laundry into the wash tub, and add detergent into it. When fill water to half of the desired water level, turn off the water tap and let laundries soak in the solution for minutes, then fill water to desired water level.
3. Set wash program "Gentle" or "Normal" as per amount and texture of laundries.
4. Turn the wash timer knob to set wash time.
5. After washing, set the wash drain selector to "Drain" position for draining.

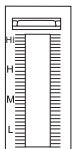
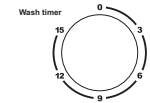

Water level indicator

Rinsing Method

A. Spraying rinse (rinse in the spin tub)

- ① Put the laundry into the spin tub after washing.
- ② Turn on the water tap, choose to fill water into the spin tub for 3-4 minutes, and then turn off the water tap.
- ③ Set the spin timer for 2-5 minutes for rinsing.
- ④ The above steps can be repeated.

Note: ① If there is red rust in water, do not choose spraying rinse, for the rust is easy to adhere to laundries.

- ② Ensure that do not fill water into spin tub when spinning.



Usage method

B. Common rinse (rinse in the wash tub)

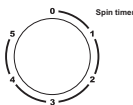
- ① To save time, water and energy, can do pre-spinning before rinsing.
- ② Put laundries which have already been dehydrated into the wash tub.
- ③ After filling water to the desired level, turn off the water tap to save water.
- ④ Turn the "Wash selector" knob to the "Gentle" or "Normal".
- ⑤ Set the "wash timer" to the desired time (about 3-5 minutes) for rinsing.
- ⑥ After rinsing, put the washing materials into the spin tub to spin for 1 to 5 minutes.
- ⑦ Drain out the rinsing water in the wash tub.
- ⑧ The above steps can be repeated.

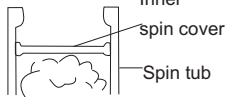

Spinning Method

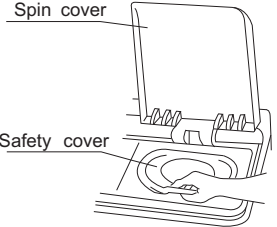
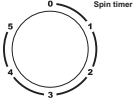
<p>1. Shake out the laundry and put them into the spin tub.</p> 	<p>2. Put the inner spin cover on the laundry. Confirm the inner spin cover is placed horizontally.</p> <div style="display: flex; justify-content: space-around;"> <div style="text-align: center;">  <p>Correct</p> </div> <div style="text-align: center;">  <p>Incorrect</p> </div> </div>														
<p>3. Close the safety cover and the spin cover.</p> 	<p>4. Refer to the following table to select spinning time.</p> <table border="1" style="width: 100%;"> <thead> <tr> <th>Washing materials</th> <th>Spin time</th> </tr> </thead> <tbody> <tr> <td>Silk</td> <td>About 50 seconds</td> </tr> <tr> <td>Light clothes (fiber/blended)</td> <td>About 1 minute</td> </tr> <tr> <td>Knitwear (fiber)</td> <td>About 1~2 minutes</td> </tr> <tr> <td>Underwear (cotton)</td> <td>About 2~3 minutes</td> </tr> <tr> <td>Slipover (cotton/linen)</td> <td>About 3~4 minutes</td> </tr> <tr> <td>Toweling coverlet (cotton)</td> <td>About 5 minutes</td> </tr> </tbody> </table> 	Washing materials	Spin time	Silk	About 50 seconds	Light clothes (fiber/blended)	About 1 minute	Knitwear (fiber)	About 1~2 minutes	Underwear (cotton)	About 2~3 minutes	Slipover (cotton/linen)	About 3~4 minutes	Toweling coverlet (cotton)	About 5 minutes
Washing materials	Spin time														
Silk	About 50 seconds														
Light clothes (fiber/blended)	About 1 minute														
Knitwear (fiber)	About 1~2 minutes														
Underwear (cotton)	About 2~3 minutes														
Slipover (cotton/linen)	About 3~4 minutes														
Toweling coverlet (cotton)	About 5 minutes														

- △The appliance can not be used by children or persons with reduced physical, sensory or mental capabilities, or lack of experience and knowledge, unless they have been given supervision or instruction.
- △The new hose supplied with the appliance are to be used and that old hose should not be used.
- △When choosing the water inflowing to wash tub or spin tub, please do not move the water inlet valve during the process of water inflowing.
- △If strong vibration occurs in time of spinning, open the spin cover immediately. Make sure that the washing machine is placed on a flat and stable floor, and then adjust washing materials, distribute them evenly.
- △To do spinning and draining together, please spin for 1 minute before draining.
- △Do not wash or spin waterproof clothes or clothes that float easily to avoid abnormal vibration or damage to the clothes.

Usage method

Efficiency Program (For efficiency program only)

The tests were carried out under program **Normal**. Below is the detail for test setting and steps;

1. Main wash: 30 min., H water level, wash temperature 40 °C;
2. Spin: 3 min., 2 times; 4 kg test load for one turn;
3. Rinse: 3 min., L water level, water temperature 20 °C;
4. Spin: 3 min., 2 times; 4 kg test load for one turn.

Special Features

A. Soak function (For machines having soak function only)

For seriously stained clothes, Soak wash is useful to achieve better wash result. 15-35 minutes of the wash timer is for soak wash: (illustrate as follows)

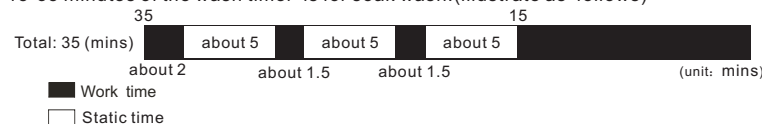

This machine can wash blended blanket (less than 3 kg) marked with the "hand washing" label. Washing method is as follows:

- ① Dilute detergent with adequate water (below 50°C), then pour the solution into the wash tub.
- ② Fold the blanket as shown in the figure, and put it into the wash tub.



- Fold in half along the long edge



- 1/3 fold in the same direction

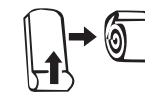

- Roll up the blanket



- Put into the tub with blanket edge facing down

B. Buzzer function (For machines having buzzer function only)

Function of the buzzer is to alarm finish of washing, and it is helpful to control wash process.

- Buzzer will alarm the completion of washing.

C. The dual voltage (For machines having the dual voltage function only)

The dual voltage washing machine can work at the voltage of 220V or 127V to meet needs of different countries and areas.

- Convert the voltage from 220V60Hz to 127V60Hz:
 - ① Unplug the washing machine plug to cut off the power supply.
 - ② Remove the back cover.
 - ③ Take down the nylon clip, and remove the plastic bag.
 - ④ Connect the "Wash 127V" of the terminal connector with "Wash", "Spin 127V" with "Spin", then the voltage can be converted to "127V60Hz".
 - ⑤ Put the wires in order, wrap them in the plastic bag, and refix the back cover. Then the washing machine can be powered for operation.
 - If convert the voltage from 127V60Hz to 220V60Hz:
 - ① ② ③ Steps ①-③ are the same as above
 - ④ Connect the "Wash 220V" of the terminal connector with "Wash", "Spin 220V" with "Spin" to convert the voltage to 220V60Hz.
 - ⑤ The step ⑤ is the same as above
- In the step ④ above, should connect the terminal connectors of both wash and spin, and make sure to connect correctly.

*The factory-set voltage is "220V60Hz". Users can choose the voltage according to the regional voltage range.

Maintenance

Attention To Maintenance

Cabinet maintenance

After using the washing machine, wipe the moisture and stain on it with a piece of soft cloth. To avoid damage to the surface, do not use corrosive or volatile chemicals.



Cleaning the lint filter

- ◆ Press the button head, and pull the lint filter out.
- ◆ Turn the filter net inside out, and rinse it in water.
- ◆ After inserting the claw, press the button to insert it into place.
- ◆ A sound of "ba" means proper installation.

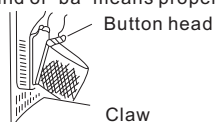

Anti-freezing protection

▲ To prevent from freezing:

- ① Turn off the water tap, remove the water inlet hose and empty water in the water inlet hose completely.
- ② Lay the drain hose and turn the drain selector knob to the "Drain" position to empty the water in the tub.

▲ If the water is frozen, please take the following steps:

- ① Put the water inlet hose into warm water of about 50°C.
- ② Keep about 2 liters of warm water below 50°C in the wash tub for about 10 minutes, and then lay the drain hose and turn the wash drain selector knob to the "Drain" position to empty the water.
- ③ Fit the water inlet hose and turn on the water tap to confirm water filling and draining work properly.



Operation when objects are dropped into the outside of the spin tub

- ① Remove all screws on the frame with a screw driver and loosen the connector of the brake belt.
- ② Pull up the frame with both hands and turn it backwards.
- ③ Take out the clothes dropped into the outside of the spin tub.
- ④ Fasten the connector of the brake belt, Press the frame to reset and tighten screws.

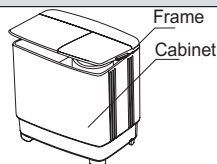

⚠ After you use the washing machine, never forget to do the following two things:

1. Disconnect the power plug.
2. Remove the water inlet hose.

Notes

The washing machine employs alternative current with rated voltage and frequency. When voltage fluctuates between -10% and 10% of the rated voltage, the machine can work normally. Connection mode of the power cord of this machine is Y-shaped connection. Users should not detach or reconnect the wire by themselves. If this part needs to be repaired, please contact the designated service center.

Maintenance

- Do not connect to the hot water supply.
- After using, be sure to unplug the power plug.
- Be sure to use plug that is properly grounded.
- The maximum gradient of the supporting surface for the washing machine should not exceed 2°.
- Do not tear down electrical wires and components in the machine by yourself.
- There are holes on the base for ventilation. These holes should not be blocked by foreign objects (carpets, etc.).
- Never connect the grounding wire with the live wire, or it may lead to an electric shock.
- If the power cord is damaged, it must be replaced by a qualified person to avoid a hazard.

If the following symptoms occur, please disconnect the power plug and perform the following checks:

Symptom	Reason
The washing machine does not work.	<ul style="list-style-type: none"> ● Check that the power supply is in good condition. ● Check that the power plug is inserted properly. ● Check that the wash timer knob or the spin timer knob is not in the "0" position.
The drain hose does not work.	<ul style="list-style-type: none"> ● Check that the drain hose is not laid too high. ● Check that the drain hose is not frozen. ● Check that the drain hose is not blocked by foreign matter.
There is abnormal noise during washing.	<ul style="list-style-type: none"> ● Check that there are no coins or any other foreign objects dropped into the wash tub.
There is abnormal noise and violent vibration during spinning.	<ul style="list-style-type: none"> ● Check that the washing machine is placed on flat, stable floor. ● Check that clothes are evenly distributed in the spin tub. ● Check that there are no washing materials or foaming debris dropped into the outside of the spin tub.

Main Technical Parameters

	Wash	Spin
Capacity (dry Clothes)	8.0 kg	4.6kg
Power Supply	240V/50Hz	
Input Power (lower drain)	400W	135W
Input Power (upper drain)	400W	135W
Maximum Time	15 min. 35 min. (soak wash)	5 min.
Water volume	HI:77L H: 72L M: 61L L: 50L	/
Maximum water pressure	0.6Mpa	
Overall dimension	870x512x957(mm)	
Net weight	Lower Drain System	23kg
	Upper Drain System	23.5kg
Pump Input Power	30W	