

WPRU75ASL

75CM Undermount Rangehood



FEATURES & BENEFITS



700m³/h Extraction

Removes cooking odours with ease



47/50/58 dB Noise Rating

Quiet operation makes this unit perfect for open plan kitchens.



LED Lighting

Giving extra light when needed in the kitchen.



3 Speed Settings

Depending on what you're cooking you can vary the amount of extraction as required.

TECHNICAL SPECIFICATIONS

CONSTRUCTION TYPE/ PRODUCT FAMILY	Undermount Rangehood
PRODUCT DIMENSIONS	(W)750 x (H)254 x (D)296
FASCIA COLOUR	Grey/Stainless Steel
SPEED SETTINGS	3
LIGHTING TYPE / POSITION	LED / Front
CONTROL TYPE / POSITION	Sliding Switch / Front
COLOUR	Stainless steel
FILTER TYPE	Aluminium or Optional Carbon Filter
FILTER CLEANING	Dishwasher Safe
MOTOR	Single
NOISE RATING	(LOW) 47dB, (MID) 50dB, (HIGH) 58dB
DUCTING DIAMETER	150mm
DUCTING DIRECTION	Can be top or rear
LENGTH OF POWER CABLE	1500mm
ELECTRICAL CONNECT REQUIREMENTS	10A
VOLTAGE (V)	240V
FREQUENCY (HZ)	50Hz
WEIGHT (kg)	8.5kg (GROSS) / 7.5kg (NET)
APPROVAL CERTIFICATES	CE

WPRU75ASL

75CM Undermount Rangehood

Product dimensions

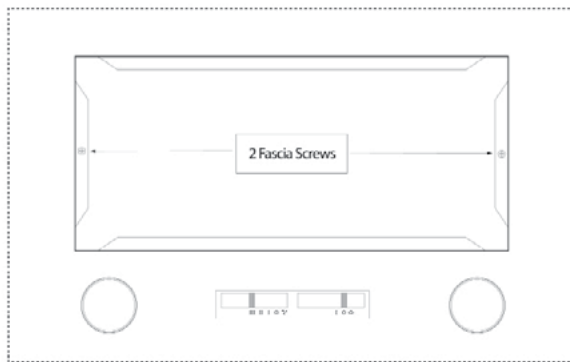
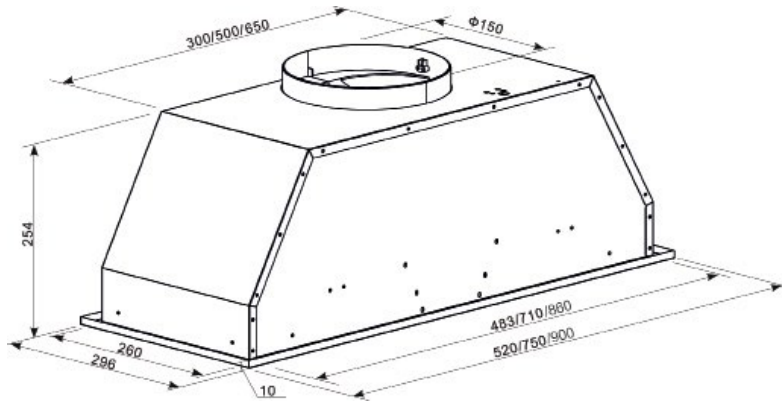

Rangehood/cooktop clearance

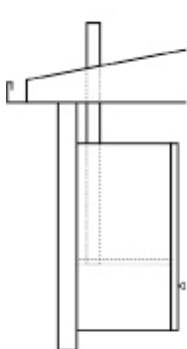
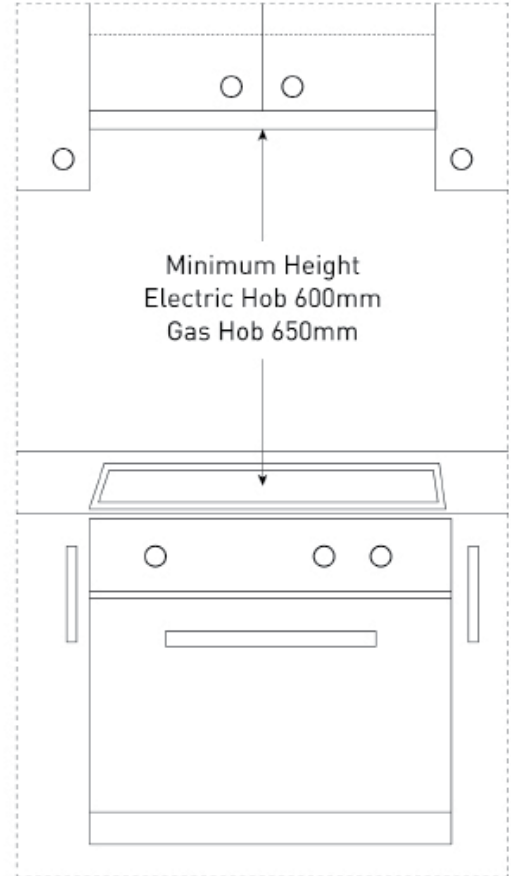

TOP DUCTING

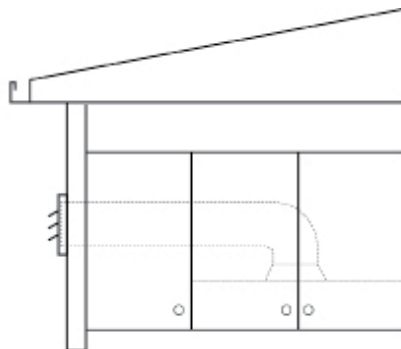

SIDE DUCTING

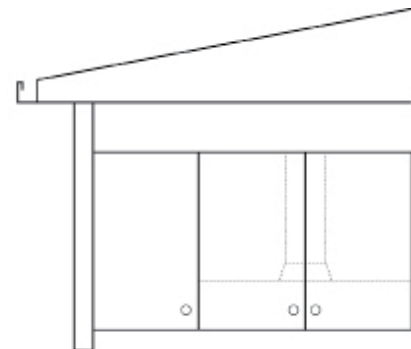

RE-CIRCULATING
(Carbon filter required)

WARNING: Technical specifications and product sizes can be varied by the manufacturer, without notice. Cut outs for appliances should only be by physical product measurements. The above is indicative only.